

DISHWASHER OUTLET BENCH 700mm DEEP LEFT OPENING

 This 700 mm sink range is modular to the Brayco 700 mm deep sinks, cabinets and splashback benches.

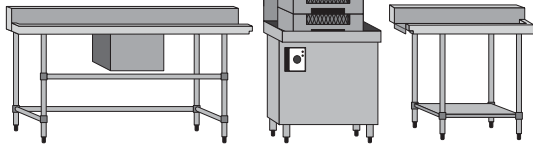

Inlet Benches:
DISHINL
DDISHINL



This DISHOUTR bench sits to the right of the dishwasher when facing it.

700 SERIES DISHWASHER OUTLET BENCH

Overall Dimensions:

800 (w) x 700 (d) x 900 mm (h)

Splashback Height: 150 mm

Shipping Dimensions:

930 (w) x 750 (d) x 290 mm (h)

Shipping Weight: 22 kg

Material:

Top: 2 mm 304 grade stainless steel

Undershelf: 2.5 mm galvanised steel

Legs: 201 grade stainless steel

PRODUCT CODE: DISHOUTR

 Brayco Stainless Steel is made from 95% recycled materials

FEATURES AND BENEFITS

- Adjustable Shelf Height.
- High Grade Stainless Steel.
- Supplied Flat Pack: Simple assembly required.
- Construction: Our units are fully stainless steel with round legs. Very sturdy.
- Adjustable Feet: Supplied attached to leg.

ADDITIONAL ITEMS

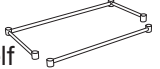
- Leg Brace Rail Kit:  Remove the undershelf and add a rail kit for extra strength.

UPGRADES

- 410 Grade Stainless Steel Legs & Screw Down Feet: Adjustable up to 20 mm.
- 201 Grade Stainless Steel Legs & Screw Down Feet: For extremely salty or chemical conditions. Adjustable up to 20 mm.

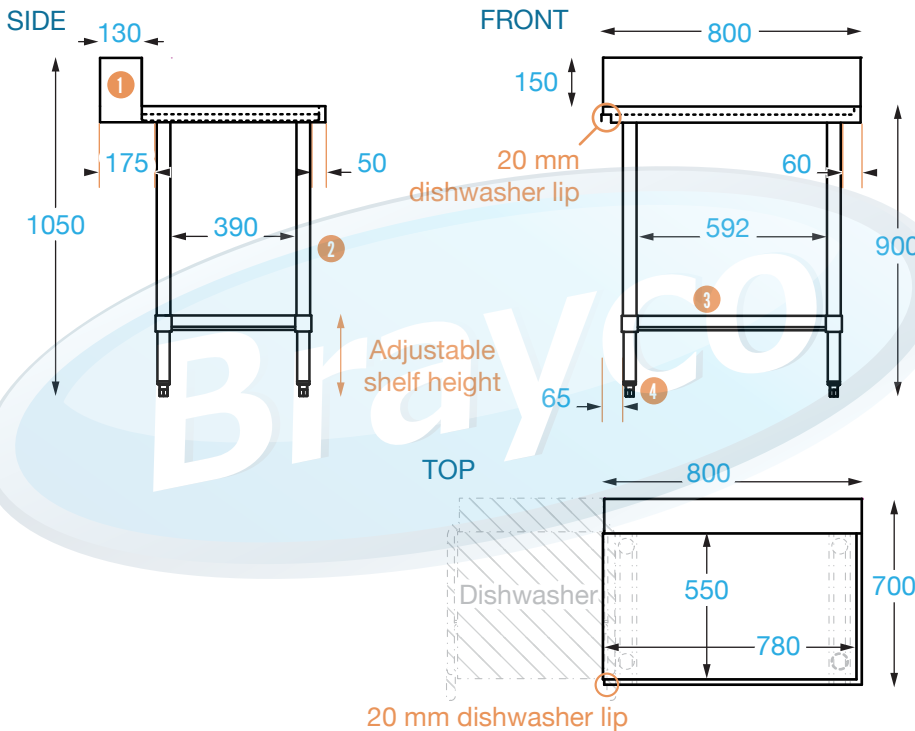

COMPONENTS

- Splashback**
150 mm (high), 130 mm (deep)
- Legs**
Ø 42
- Undershelf**
2.5 mm (adjustable height)
- Adjustable feet**
Adjustable up to 35 mm

 These products are compliant with all applicable Australian health department regulations.

 It is important that your stainless steel is kept clean to extend the lifetime of the product.



Brisbane • Sydney • Melbourne • Hobart • Adelaide • Perth • Auckland
For more info please contact your nearest Brayco Branch 1300 272 926 | brayco.com.au